

BYIBA
L I G H T



QUATRO S
(track)

BY-43-TR

PROJECT

SPEC TYPE

NOTES



GENERAL INFORMATION:

The Quatro S Non-Magnetic Track system offers both 1-Circuit and 3-Circuit track profiles, available in lengths of 39.4" (100 cm), 78.7" (200 cm), and 118" (300 cm). It operates at 110-277V and is made from aluminum with an electrostatic powder coating, offered in white or black finishes.

The system includes one linear light model, measuring L: 18.5" (47 cm) x H: 4.72" (12 cm), with a power output of 36W and 2624 lm luminous flux. The light can be adjusted to a 90° or 45° angle, depending on the track profile. Available CCT options include 3000K, 4000K, and 5000K, with CRI options of 80 or 90. The light finishes are available in white, black, or gray.

MATERIAL:

AL, Electrostatic Powder Coating

FINISHING:

White, Black, Gray

LIGHTING:

LED

VOLTAGE:

110-277V

IP RATING:

20

OPERATING TEMPERATURE RANGE:

-20 to +40 C

WWW.BULLARDCOLLECTION.COM

TECHNICAL

OUTDOOR

DECORATIVE



WE WELCOME ALL CUSTOM ORDERS

CONTACT US:

sales@gordonbullard.com

www.byiba.com

1 877-964-4646

PROJECT

SPEC TYPE

NOTES

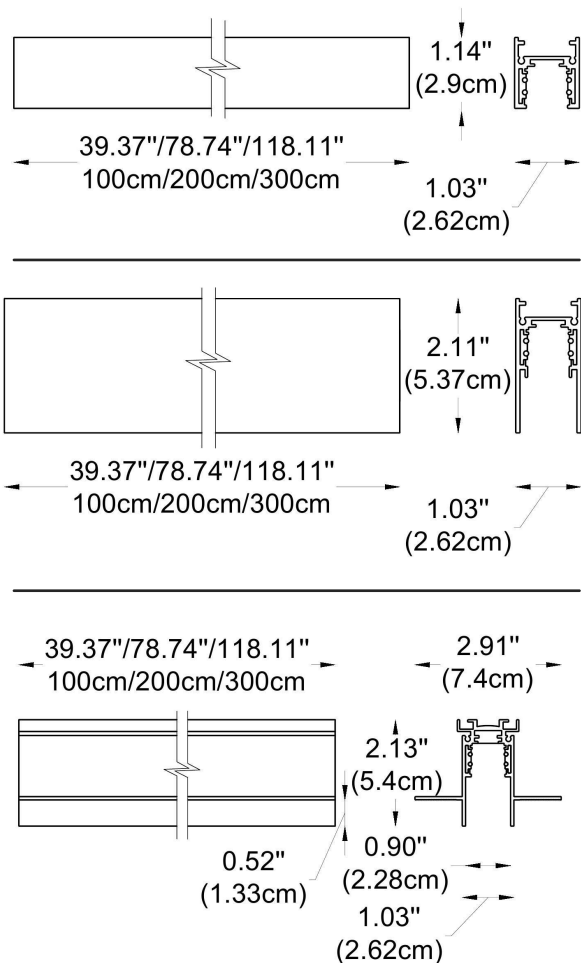

HOW TO ORDER:

CODE:

Example:
CODE: BY-43-TR-1-01-BL-651-W0-K30-C80-B1-WL

BY-43-TR-1-01-
BL-651-W0-K30-
C80-B1-WL

1 CHOOSE TRACK MODEL:

1-Circuit Track Profile



- 1-01 L: 39.4" (100 cm)
- 1-02 L: 78.7" (200 cm)
- 1-03 L: 118" (300 cm)

3-Circuit Track Profile

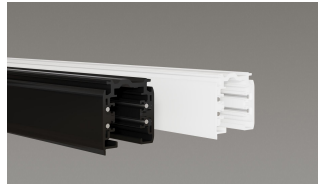

- 2-01 L: 39.4" (100 cm)
- 2-02 L: 78.7" (200 cm)
- 2-03 L: 118" (300 cm)

2 FINISH OPTION TRACK PROFILE:

- BL Black
- WH White

WWW.BULLARDCOLLECTION.COM

- TECHNICAL
- OUTDOOR
- DECORATIVE



WE WELCOME ALL CUSTOM ORDERS

CONTACT US:

sales@gordonbullard.com
www.byiba.com
1 877-964-4646

PROJECT

SPEC TYPE

NOTES

HOW TO ORDER:

CODE:

Example:
CODE: BY-43-TR-1-01-BL-65510-K30-C80-B1-WL

BY-43-TR-1-01-
BL-65510-K30-
C80-B1-WL

3 CHOOSE TRACK HEAD:

GENERAL INFORMATION

CODE - -65510
 Dimensions: L: 18.5" (47 cm) x H: 4.72" (12 cm)
 Housing: AL. Extrude, Electrostatic Powder Coating
 Reflector: Lens
 Gear Box: AL. Extrude, Electrostatic Powder Coating
 Light Source: LED
 Power: 36W
 Currents: 700 mA
 Luminous Flux: 2624 lm

CCT: -K30 - 3000K
 -K40 - 4000K
 -K50 - 5000K

CRI: -C80 - 80
 -C90 - 90

Finish Options: -WL - White
 -BL - Black
 -GR - Gray

ADJUSTABLE ANGLE:

2P (1 CIRCUIT TRACK)

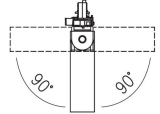

4P (3 CIRCUIT TRACK)

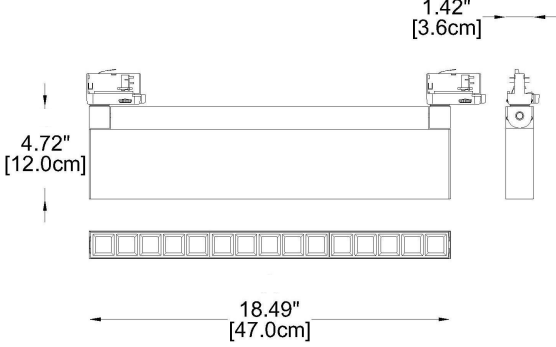
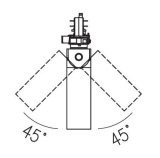

LED IP20

WWW.BULLARDCOLLECTION.COM

- TECHNICAL
- OUTDOOR
- DECORATIVE



WE WELCOME ALL CUSTOM ORDERS

CONTACT US:

sales@gordonbullard.com
www.byiba.com
 1 877-964-4646

PROJECT

SPEC TYPE

NOTES

HOW TO ORDER:

Example:
CODE: BY-43-TR-1-01-BL-65510-K30-C80-B1-WL

CODE:

BY-43-TR-1-01-
BL-65510-K30-
C80-B1-WL

PHOTOMETRIC:

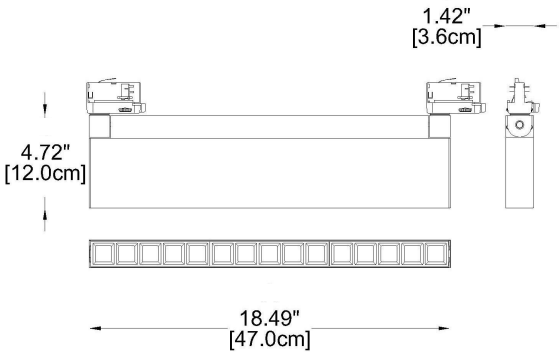
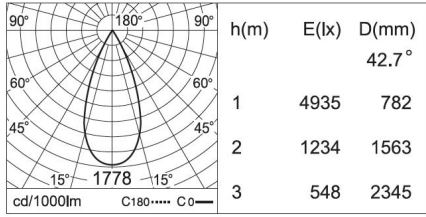

LED
110-277V
IP20
90°
355°

WWW.BULLARDCOLLECTION.COM

- TECHNICAL
- OUTDOOR
- DECORATIVE



WE WELCOME ALL CUSTOM ORDERS

CONTACT US:

sales@gordonbullard.com
www.byiba.com
1 877-964-4646

ACCESSORIES FOR 1 CIRCUIT TRACK:

-105
Feed-in Cap
 -BL - Black
 -WH - White

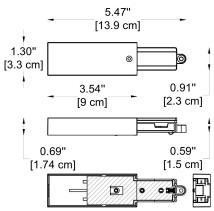

-106
End Cap
 -BL - Black
 -WH - White

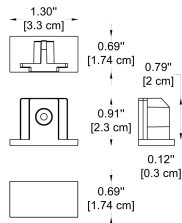

-107
Straight Connector
 -BL - Black
 -WH - White

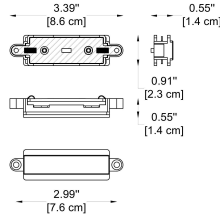

-108
L Connector
 -BL - Black
 -WH - White

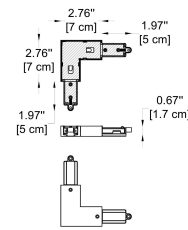
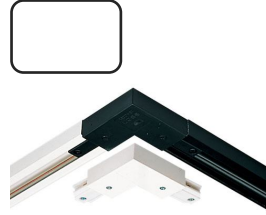

-110
T Connector
 -BL - Black
 -WH - White

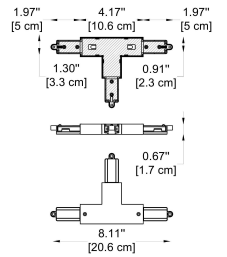
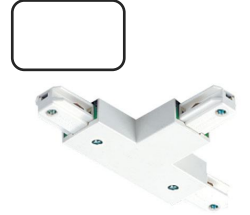

-111
X Connector
 -BL - Black
 -WH - White

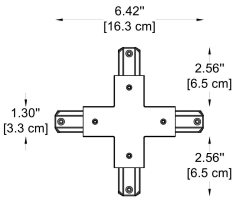
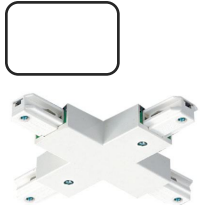

-153
Adapter
 -BL - Black
 -WH - White

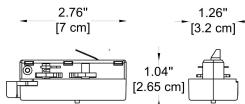
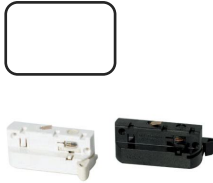

HOW TO ORDER:

Example:
 CODE: 105-WH

WWW.BULLARDCOLLECTION.COM

TECHNICAL

OUTDOOR

DECORATIVE



WE WELCOME ALL CUSTOM ORDERS

CONTACT US:

sales@gordonbullard.com
www.byiba.com
 1 877-964-4646

ACCESSORIES FOR 3CIRCUIT TRACK:

-305
Feed-in Cap
 -BL - Black
 -WH - White

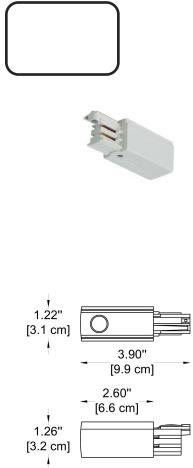

-306
End Cap
 -BL - Black
 -WH - White

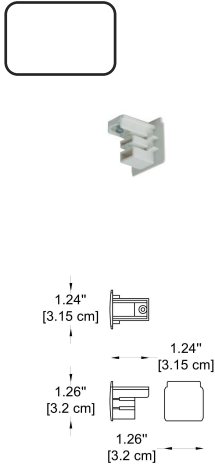

-307
Straight Connector
 -BL - Black
 -WH - White

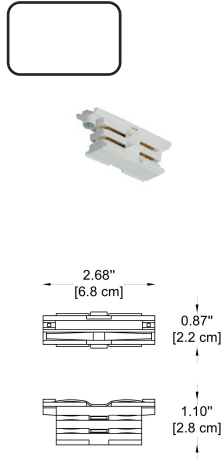

-308
L Connector
 -BL - Black
 -WH - White

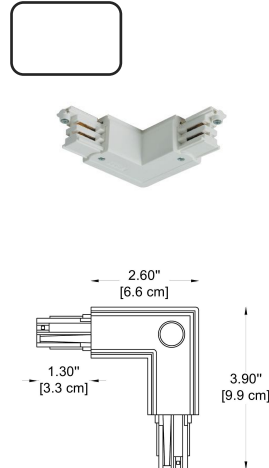

-310
T Connector
 -BL - Black
 -WH - White

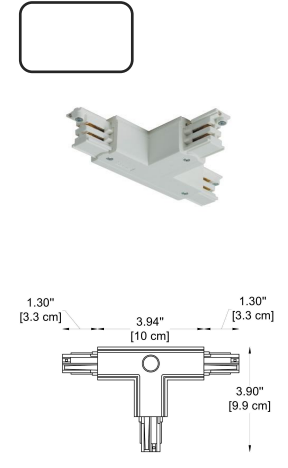

-311
X Connector
 -BL - Black
 -WH - White

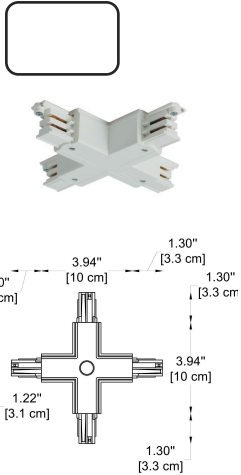

-351
Adapter
 -BL - Black
 -WH - White

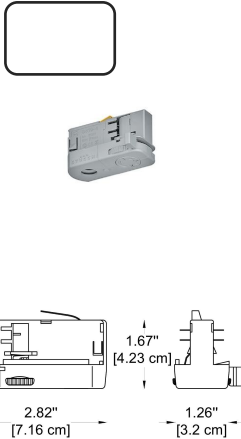

HOW TO ORDER:

Example:
 CODE: -305-BL