

**BYIBA**  
L I G H T



**MACARON**  
(track)

BY-43-TR

PROJECT

SPEC TYPE

NOTES



**GENERAL INFORMATION:**

The Macaron Non-Magnetic Track collection features 1-Circuit and 3-Circuit track profiles in three lengths: 39.4" (100 cm), 78.7" (200 cm), and 118" (300 cm), designed for a voltage range of 110-277V. Available in white or black finishes, the track profiles are made from aluminum (AL) with an electrostatic powder coating for durability.

This collection includes two spotlight models, each measuring Ø 4.53" (11.5 cm) x W 2.6" (6.6 cm), with wattage options of 18W or 27W. The spotlights offer CCT choices of 3000K or 4000K, CRI options of 80 or 90, and are available in white, black, or gray finishes.

**MATERIAL:**

AL, Electrostatic Powder Coating

**FINISHING:**

White, Black

**LIGHTING:**

LED

**VOLTAGE:**

110-277V

**IP RATING:**

20

**OPERATING TEMPERATURE RANGE:**

-20 to +40 C



[WWW.BULLARDCOLLECTION.COM](http://WWW.BULLARDCOLLECTION.COM)

TECHNICAL

OUTDOOR

DECORATIVE



WE WELCOME ALL CUSTOM ORDERS

CONTACT US:

[sales@gordonbullard.com](mailto:sales@gordonbullard.com)

[www.byiba.com](http://www.byiba.com)

1 877-964-4646

PROJECT

SPEC TYPE

NOTES

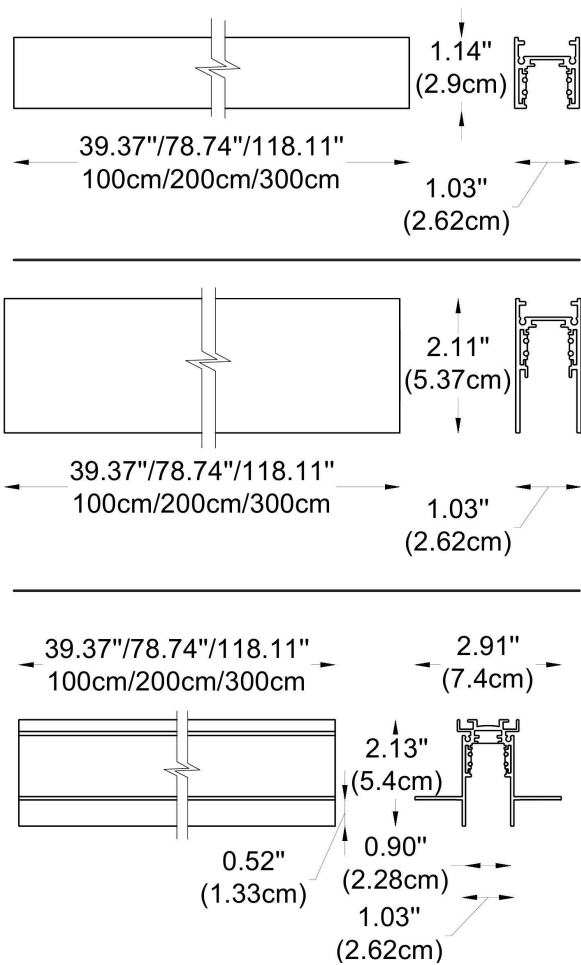

## HOW TO ORDER:

## CODE:

Example:  
CODE: BY-43-TR-1-01-BL-65070-03-K30-C80-B1-WL

BY-43-TR-  
BL1-01-65560-0  
1-K30-C80-WL

## 1 CHOOSE TRACK MODEL:

### 1-Circuit Track Profile



- 1-01 L: 39.4" (100 cm)
- 1-02 L: 78.7" (200 cm)
- 1-03 L: 118" (300 cm)

### 3-Circuit Track Profile

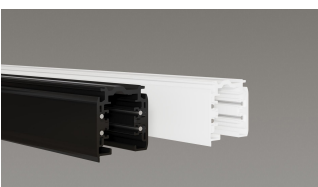

- 2-01 L: 39.4" (100 cm)
- 2-02 L: 78.7" (200 cm)
- 2-03 L: 118" (300 cm)

## 2 FINISH OPTION TRACK PROFILE:

- BL Black
- WH White

[WWW.BULLARDCOLLECTION.COM](http://WWW.BULLARDCOLLECTION.COM)

- TECHNICAL
- OUTDOOR
- DECORATIVE



CONTACT US:

sales@gordonbullard.com  
[www.byiba.com](http://www.byiba.com)  
1 877-964-4646

WE WELCOME ALL CUSTOM ORDERS

PROJECT

SPEC TYPE

NOTES

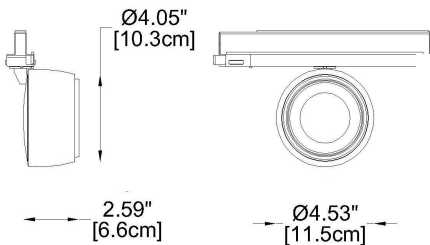

## HOW TO ORDER:

## CODE:

Example:  
CODE: BY-43-TR-1-01-BL-65380-K30-C80-B1-WL

BY-43-TR-  
BL1-01-65380-  
K30-C80-WL

## 1 CHOOSE TRACK HEAD:

### GENERAL INFORMATION

**CODE -** -65380  
 Dimensions: Ø: 4.53" (11.5 cm) x W: 2.6" (6.6 cm)  
 Housing: AL. Extrude, Electrostatic Powder Coating  
 Reflector: Lens  
 Light Source: LED (COB)  
 Power: 18W  
 Output Current 500 mA

CCT: **-K30** - 3000K  
**-K40** - 4000K

CRI: **-C80** - 80  
**-C90** - 90

Beam Angle and lumens: **-B1** - 17.8° = 1912 lm  
**-B2** - 27.7° = 1907 lm  
**-B3** - 43.8° = 2021 lm

Finish options: **-WL** - White   
**-BL** - Black   
**-GR** - Gray

Operating temperature range - -20 to +40°C  
 Maintenance of lumen - L80 - 50 000 hours at 25 °C

### PHOTOMETRICS:

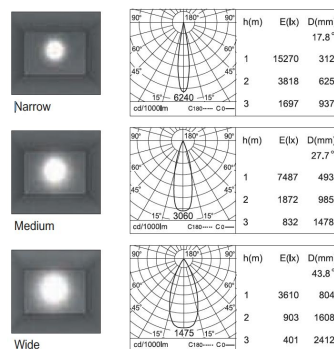

PROJECT

SPEC TYPE

NOTES

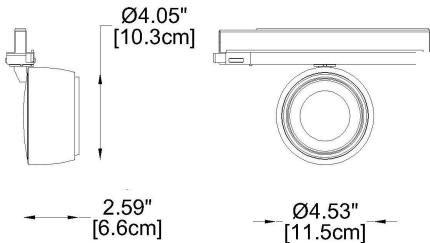

## HOW TO ORDER:

Example:  
CODE: BY-50-TR-1-01-BL-65380-K30-C80-B1-WL

## CODE:

BY-43-TR-  
BL1-01-65380-  
K30-C80-WL

## 1 CHOOSE TRACK HEAD:

### GENERAL INFORMATION

CODE - **-65381**

Dimensions: Ø: 4.53" (11.5 cm) x W: 2.6" (6.6 cm)

Housing: AL. Extrude, Electrostatic Powder Coating

Reflector: Lens

Light Source: LED (COB)

Power: 27W

Output Current 700 mA

CCT: **-K30 - 3000K**

**-K40 - 4000K**

CRI: **-C80 - 80**

**-C90 - 90**

Beam Angle **-B1 - 18.2° = 2527 lm**

and lumens: **-B2 - 27.7° = 2599 lm**

**-B3 - 43.4° = 2649 lm**

Finish options: **-WL - White** 

**-BL - Black** 

**-GR - Gray** 

Operating temperature range - -20 to +40°C

Maintenance of lumen - L80 - 50 000 hours at 25 °C

### PHOTOMETRICS:



Narrow

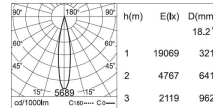

Medium

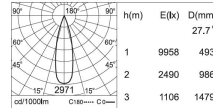

Wide

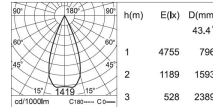

[WWW.BULLARDCOLLECTION.COM](http://WWW.BULLARDCOLLECTION.COM)

TECHNICAL

OUTDOOR

DECORATIVE



CONTACT US:

[sales@gordonbullard.com](mailto:sales@gordonbullard.com)

[www.byiba.com](http://www.byiba.com)

1 877-964-4646

WE WELCOME ALL CUSTOM ORDERS

## ACCESSORIES FOR 1 CIRCUIT TRACK:

**-105**  
**Feed-in Cap**  
 -BL - Black  
 -WH - White

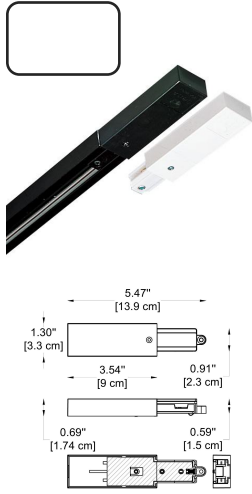

**-106**  
**End Cap**  
 -BL - Black  
 -WH - White

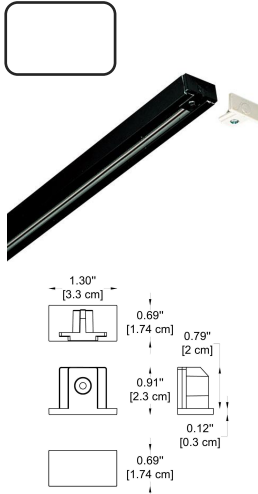

**-107**  
**Straight Connector**  
 -BL - Black  
 -WH - White

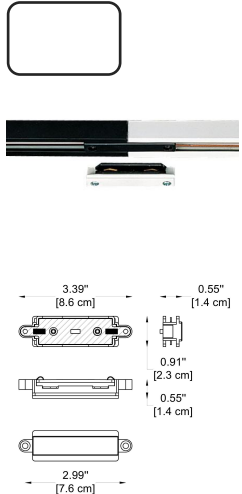

**-108**  
**L Connector**  
 -BL - Black  
 -WH - White

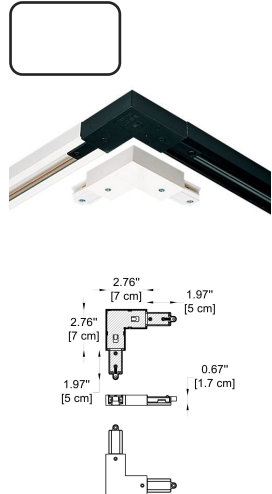

**-110**  
**T Connector**  
 -BL - Black  
 -WH - White

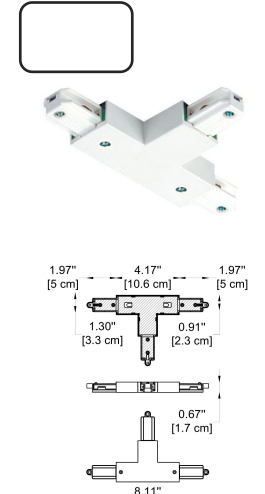

**-111**  
**X Connector**  
 -BL - Black  
 -WH - White

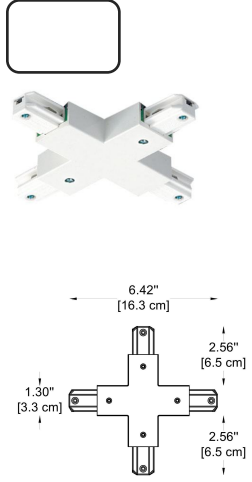

**-153**  
**Adapter**  
 -BL - Black  
 -WH - White

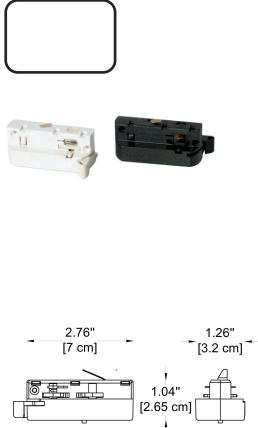

### HOW TO ORDER:

Example:  
 CODE: 105-WH

[WWW.BULLARDCOLLECTION.COM](http://WWW.BULLARDCOLLECTION.COM)

- TECHNICAL
- OUTDOOR
- DECORATIVE



CONTACT US:

sales@gordonbullard.com  
[www.byiba.com](http://www.byiba.com)  
 1 877-964-4646

WE WELCOME ALL CUSTOM ORDERS

## ACCESSORIES FOR 3CIRCUIT TRACK:

**-305**  
**Feed-in Cap**  
 -BL - Black  
 -WH - White

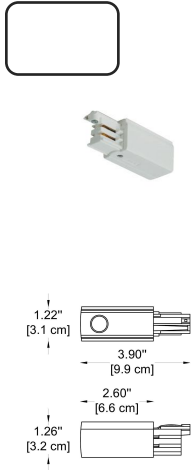

**-306**  
**End Cap**  
 -BL - Black  
 -WH - White

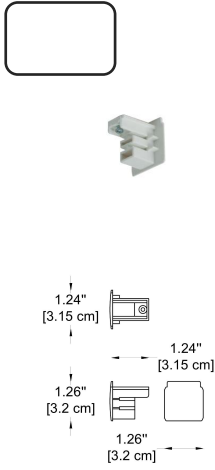

**-307**  
**Straight Connector**  
 -BL - Black  
 -WH - White

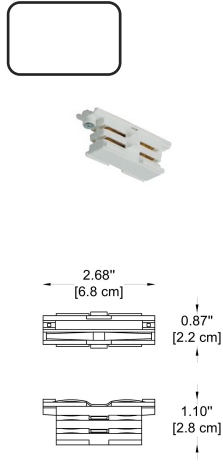

**-308**  
**L Connector**  
 -BL - Black  
 -WH - White

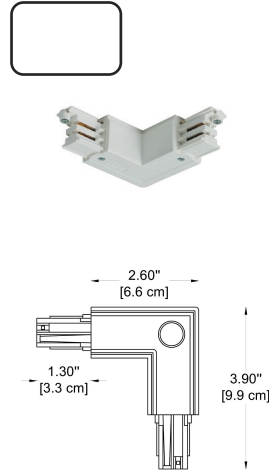

**-310**  
**T Connector**  
 -BL - Black  
 -WH - White

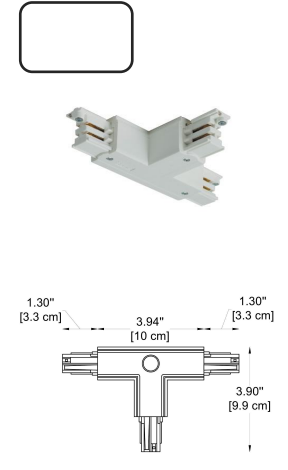

**-311**  
**X Connector**  
 -BL - Black  
 -WH - White

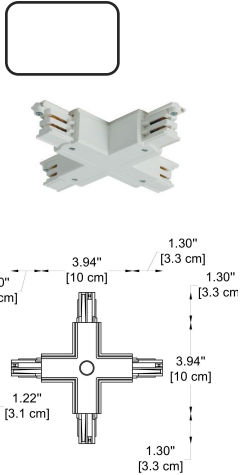

**-351**  
**Adapter**  
 -BL - Black  
 -WH - White

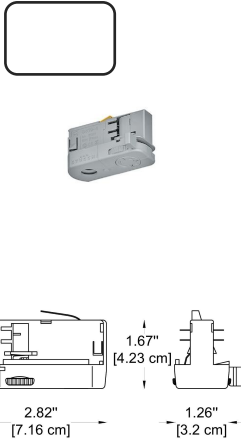

## HOW TO ORDER:

Example:  
 CODE: -305-BL

[WWW.BULLARDCOLLECTION.COM](http://WWW.BULLARDCOLLECTION.COM)

- TECHNICAL
- OUTDOOR
- DECORATIVE



CONTACT US:

sales@gordonbullard.com  
[www.byiba.com](http://www.byiba.com)  
 1 877-964-4646

WE WELCOME ALL CUSTOM ORDERS