

BYIBA
L I G H T



FLOW S COLLECTION
(track)

BY-43-TR

PROJECT

SPEC TYPE

NOTES



GENERAL INFORMATION:

The Flow S Non-Magnetic Track Collection offers 1-Circuit and 3-Circuit surface-mounted track profiles available in three lengths—39.4" (100 cm), 78.7" (200 cm), and 118" (300 cm)—with a voltage of 110-277V. Available in White or Black, with an electrostatic powder-coated aluminum finish.

The collection includes four spotlight models:

- Ø: 1.4" (3.5 cm) x H: 3.74" (9.5 cm)
- Ø: 2" (5 cm) x H: 4.3" (11 cm)
- Ø: 2.36" (6 cm) x H: 5.3" (13.5 cm)
- Ø: 2.36" (6 cm) x H: 3.62" (9.2 cm)

Spotlights are offered in CCT options of 3000K, 4000K, and 5000K, with CRI ratings of 80 or 90, and are available in White or Black finishes. Ideal for indoor applications.

MATERIAL:

AL, Electrostatic Powder Coating

FINISHING:

White, Black

LIGHTING:

LED

VOLTAGE:

110-277V

IP RATING:

20

OPERATING TEMPERATURE RANGE:

-20 to +40 C



WWW.BULLARDCOLLECTION.COM

TECHNICAL

OUTDOOR

DECORATIVE



CONTACT US:

sales@gordonbullard.com
www.byiba.com
1 877-964-4646

WE WELCOME ALL CUSTOM ORDERS

PROJECT

SPEC TYPE

NOTES

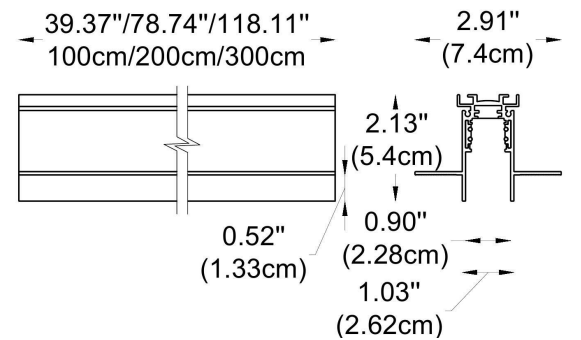
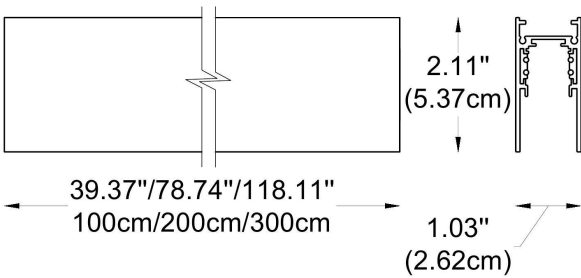
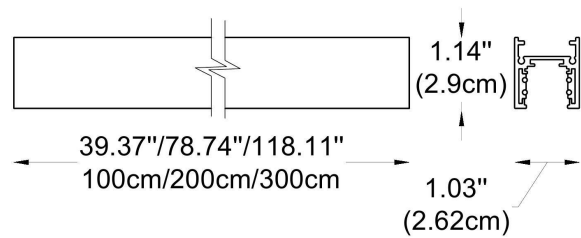

HOW TO ORDER:

CODE:

Example:
CODE: BY-43-TR-1-01-BL-65020-01-K30-C80-B1-WL

BY-43-TR-1-01-
BL-65020-01-
K30-C80-B1-
WL

1 CHOOSE TRACK MODEL:

1-Circuit Track Profile



- 1-01 L: 39.4" (100 cm)
- 1-02 L: 78.7" (200 cm)
- 1-03 L: 118" (300 cm)

3-Circuit Track Profile

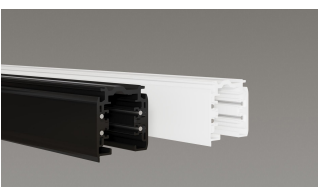

- 2-01 L: 39.4" (100 cm)
- 2-02 L: 78.7" (200 cm)
- 2-03 L: 118" (300 cm)

2 FINISH OPTION TRACK PROFILE:

- BL Black
- WH White

WWW.BULLARDCOLLECTION.COM

- TECHNICAL
- OUTDOOR
- DECORATIVE



CONTACT US:

sales@gordonbullard.com
www.byiba.com
1 877-964-4646

WE WELCOME ALL CUSTOM ORDERS

PROJECT

SPEC TYPE

NOTES

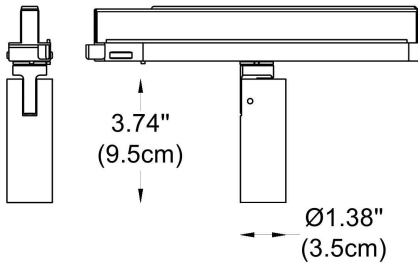

HOW TO ORDER:

CODE:

Example:
CODE: BY-43-TR-1-01-BL-65020-01-K30-C80-B1-WL

BY-43-TR-1-01-
BL-65020-01-
K30-C80-B1-
WL

1 CHOOSE TRACK HEAD:

GENERAL INFORMATION

CODE - -65020-01
 Dimensions: Ø: 1.4" (3.5 cm) x H: 3.74" (9.5 cm)
 Housing: AL. Extrude, Electrostatic Powder Coating
 Reflector: Lens
 Light Source: LED
 Power: 9W
 Output Current 450 mA

CCT: -K30 - 3000K
 -K40 - 4000K
 -K50 - 5000K

CRI: -C80 - 80
 -C90 - 90

Beam Angle and lumens: -B1 - 12.5° = 419 lm
 -B2 - 17.5° = 396 lm
 -B3 - 25.5° = 394 lm

Finish options: -WL - White
 -BL - Black

Operating temperature range - -20 to +40°C
 Maintenance of lumen - L80 - 50 000 hours at 25 °C

PHOTOMETRICS:

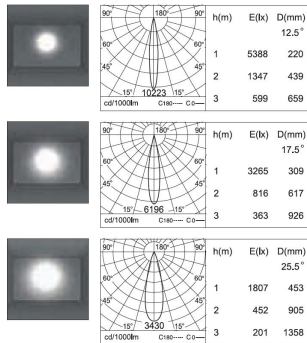

WWW.BULLARDCOLLECTION.COM

- TECHNICAL
- OUTDOOR
- DECORATIVE



CONTACT US:

sales@gordonbullard.com
www.byiba.com
 1 877-964-4646

WE WELCOME ALL CUSTOM ORDERS

PROJECT

SPEC TYPE

NOTES

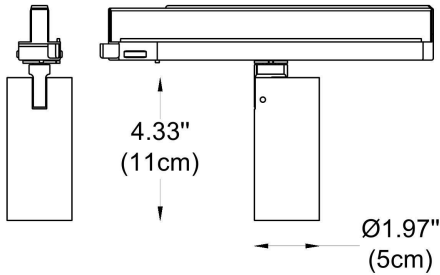

HOW TO ORDER:

CODE:

Example:
CODE: BY-43-TR-1-01-BL-65020-01-K30-C80-B1-WL

BY-43-TR-1-01-
BL-65020-01-
K30-C80-B1-
WL

1 CHOOSE TRACK HEAD:

GENERAL INFORMATION

CODE - **-65070-07**

Dimensions: Ø: 2" (5 cm) x H: 4.3" (11 cm)
Housing: AL. Extrude, Electrostatic Powder Coating
Reflector: PC (Vacuum Coating)
Light Source: LED (COB)
Power: 15W
Output Current 350 mA

CCT: **-K30 - 3000K**
-K40 - 4000K

CRI: **-C80 - 80**
-C90 - 90

Beam Angle **-B1 - 13.8° = 1184 lm**
and lumens: **-B2 - 23.3° = 1252 lm**
-B3 - 38.5° = 1032 lm

Finish options: **-WL - White**
-BL - Black

Operating temperature range - -20 to +40°C
Maintenance of lumen - L80 - 50 000 hours at 25 °C

PHOTOMETRICS:

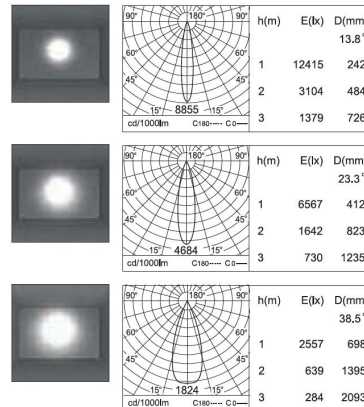

WWW.BULLARDCOLLECTION.COM

TECHNICAL

OUTDOOR

DECORATIVE



WE WELCOME ALL CUSTOM ORDERS

CONTACT US:

sales@gordonbullard.com
www.byiba.com
1 877-964-4646

PROJECT

SPEC TYPE

NOTES

HOW TO ORDER:

Example:
CODE: BY-43-TR-1-01-BL-65020-01-K30-C80-B1-WL

CODE:

BY-43-TR-1-01-
BL-65020-01-
K30-C80-B1-
WL

1 CHOOSE TRACK HEAD:

GENERAL INFORMATION

CODE - -65030-01
 Dimensions: Ø: 2.36" (6 cm) x H: 5.3" (13.5 cm)
 Housing: AL. Extrude, Electrostatic Powder Coating
 Reflector: Lens
 Light Source: LED (COB)
 Power: 21W
 Output Current 600 mA

CCT: -K30 - 3000K
 -K40 - 4000K

CRI: -C80 - 80
 -C90 - 90

Beam Angle and lumens: -B1 - 23.5° = 2610 lm
 -B2 - 31° = 2623 lm
 -B3 - 47.2° = 2676 lm

Finish options: -WL - White
 -BL - Black

Operating temperature range - -20 to +40°C
 Maintenance of lumen - L80 - 50 000 hours at 25 °C

PHOTOMETRICS:

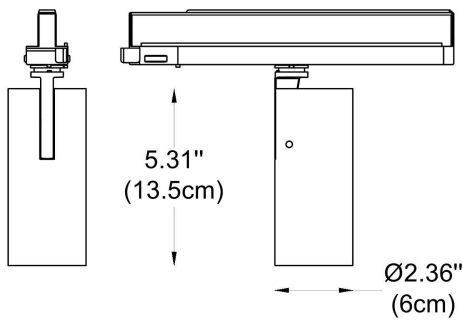
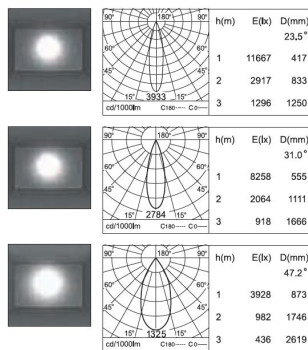

WWW.BULLARDCOLLECTION.COM

- TECHNICAL
- OUTDOOR
- DECORATIVE



WE WELCOME ALL CUSTOM ORDERS

CONTACT US:

sales@gordonbullard.com
www.byiba.com
 1 877-964-4646

PROJECT

SPEC TYPE

NOTES

HOW TO ORDER:

Example:
CODE: BY-43-TR-1-01-BL-65020-01-K30-C80-B1-WL

CODE:

BY-43-TR-1-01-
BL-65020-01-
K30-C80-B1-
WL

1 CHOOSE TRACK HEAD:

GENERAL INFORMATION

CODE - **-65030-07**

Dimensions: Ø: 2.36" (6 cm) x H: 3.62" (9.2 cm)

Housing: AL. Extrude, Electrostatic Powder Coating

Reflector: Lens

Light Source: LED (COB)

Power: 17W

Output Current 400 mA

CCT: **-K30 - 3000K**

-K40 - 4000K

CRI: **-C80 - 80**

-C90 - 90

Beam Angle: -15.2~47.9°

Finish options: **-WL - White**

-BL - Black

Operating temperature range - -20 to +40°C

Maintenance of lumen - L80 - 50 000 hours at 25 °C

PHOTOMETRICS:

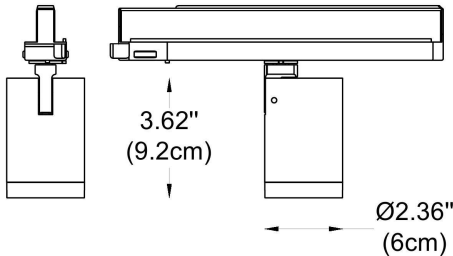

Zoom IN

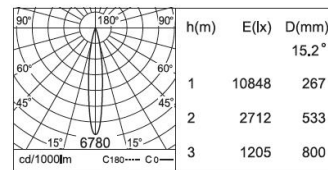

Zoom OUT

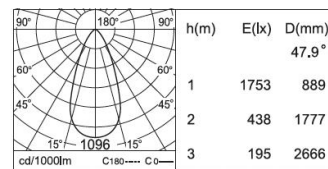

WWW.BULLARDCOLLECTION.COM

- TECHNICAL
- OUTDOOR
- DECORATIVE



WE WELCOME ALL CUSTOM ORDERS

CONTACT US:

sales@gordonbullard.com
www.byiba.com
1 877-964-4646

ACCESSORIES FOR 1 CIRCUIT TRACK:

-105
Feed-in Cap
 -BL - Black
 -WH - White

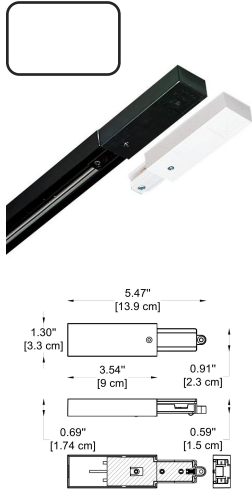

-106
End Cap
 -BL - Black
 -WH - White

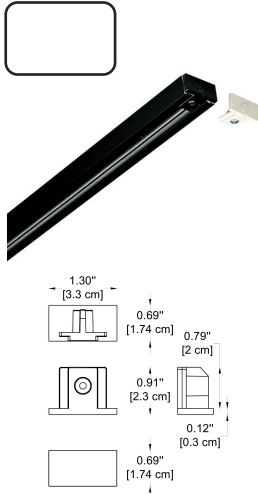

-107
Straight Connector
 -BL - Black
 -WH - White

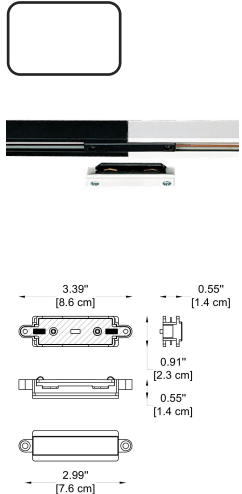

-108
L Connector
 -BL - Black
 -WH - White

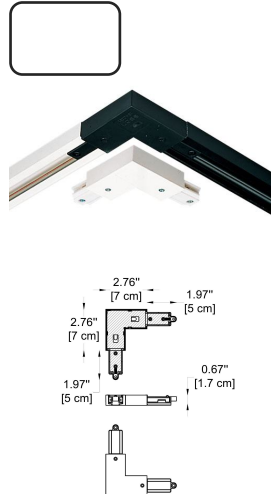

-110
T Connector
 -BL - Black
 -WH - White

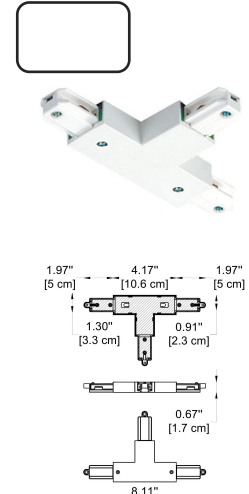

-111
X Connector
 -BL - Black
 -WH - White

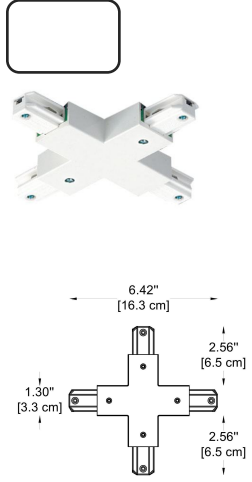

-153
Adapter
 -BL - Black
 -WH - White

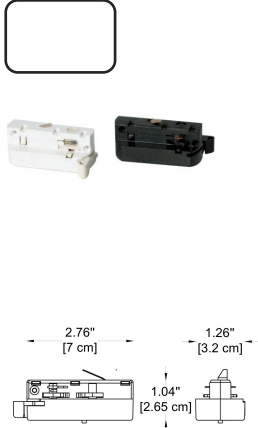

HOW TO ORDER:

Example:
 CODE: 105-WH

WWW.BULLARDCOLLECTION.COM

- TECHNICAL
- OUTDOOR
- DECORATIVE



CONTACT US:

sales@gordonbullard.com
www.byiba.com
 1 877-964-4646

WE WELCOME ALL CUSTOM ORDERS

ACCESSORIES FOR 3CIRCUIT TRACK:

-305
Feed-in Cap
-BL - Black
-WH - White

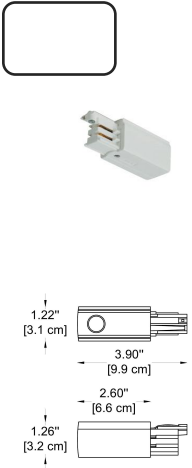

-306
End Cap
-BL - Black
-WH - White

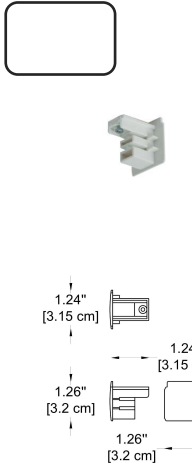

-307
Straight Connector
-BL - Black
-WH - White

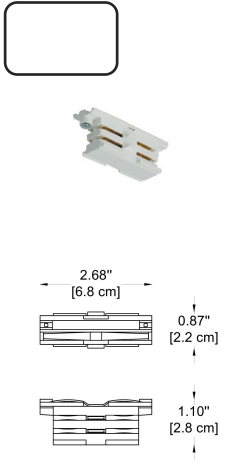

-308
L Connector
-BL - Black
-WH - White

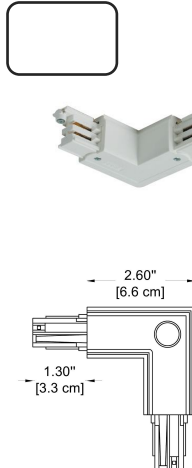

-310
T Connector
-BL - Black
-WH - White

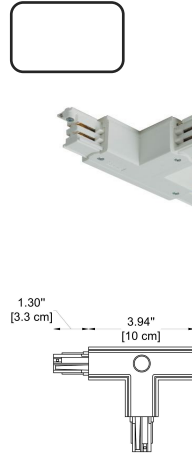

-311
X Connector
-BL - Black
-WH - White

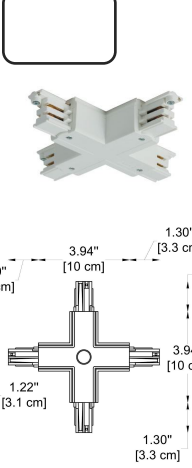

-351
Adapter
-BL - Black
-WH - White

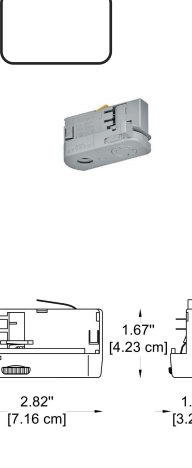

HOW TO ORDER:

Example:
CODE: -305-BL