

**BYIBA**  
L I G H T



**AURORA**  
(track)

BY-43-TR

PROJECT

SPEC TYPE

NOTES



**GENERAL INFORMATION:**

The Aurora Non-Magnetic Track system includes both 1-Circuit and 3-Circuit profiles, available in lengths of 39.4" (100 cm), 78.7" (200 cm), and 118" (300 cm). Operating at 110-277V, it features a durable aluminum construction with electrostatic powder coating, offered in white or black finishes.

The spotlight model measures Ø 5.75" (14.6 cm) x H 6.9" (17.6 cm) and is available in 31W or 42W options. The reflector is made of anodized specular silver, or can feature a lens. The spotlight offers CCT options of 3000K or 4000K and CRI ratings of 80 or 90, available in white, black, or gray finishes.

**MATERIAL:**

AL, Electrostatic Powder Coating

**FINISHING:**

White, Black, Gray

**LIGHTING:**

LED

**VOLTAGE:**

110-277V

**IP RATING:**

20

**OPERATING TEMPERATURE RANGE:**

-20 to +40 C



[WWW.BULLARDCOLLECTION.COM](http://WWW.BULLARDCOLLECTION.COM)

TECHNICAL

OUTDOOR

DECORATIVE



WE WELCOME ALL CUSTOM ORDERS

CONTACT US:

sales@gordonbullard.com  
[www.byiba.com](http://www.byiba.com)  
1 877-964-4646

PROJECT

SPEC TYPE

NOTES

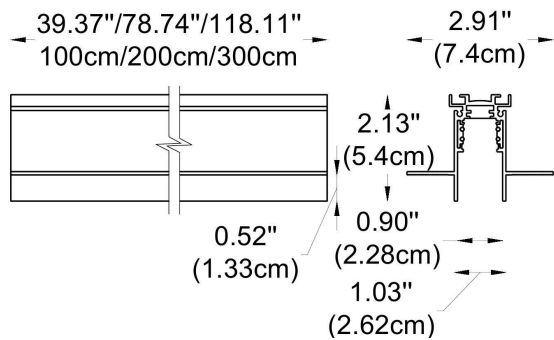
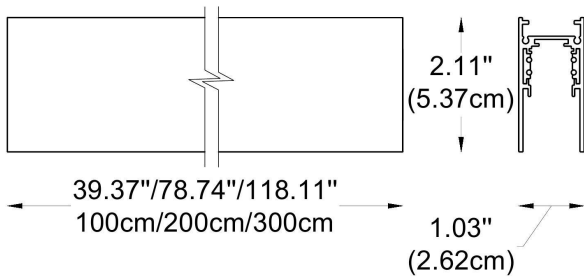
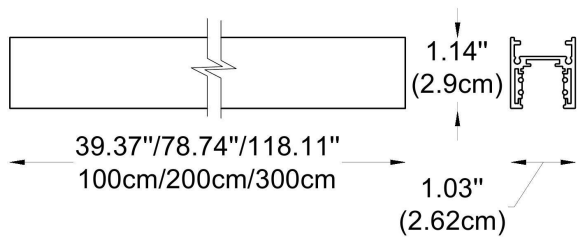

## HOW TO ORDER:

CODE:

Example:  
CODE: BY-43-TR-1-01-BL-63732-03-K30-C80-B1-WL

BY-43-TR-  
BL1-01-63732-0  
1-K30-C80-WL

## 1 CHOOSE TRACK MODEL:

### 1-Circuit Track Profile



-1-01 L: 39.4" (100 cm)

-1-02 L: 78.7" (200 cm)

-1-03 L: 118" (300 cm)

### 3-Circuit Track Profile

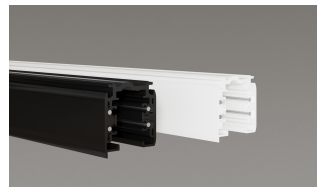

-2-01 L: 39.4" (100 cm)

-2-02 L: 78.7" (200 cm)

-2-03 L: 118" (300 cm)

## 2 FINISH OPTION TRACK PROFILE:

-BL Black  
-WH White

[WWW.BULLARDCOLLECTION.COM](http://WWW.BULLARDCOLLECTION.COM)

TECHNICAL

OUTDOOR

DECORATIVE



WE WELCOME ALL CUSTOM ORDERS

CONTACT US:

[sales@gordonbullard.com](mailto:sales@gordonbullard.com)

[www.byiba.com](http://www.byiba.com)

1 877-964-4646

PROJECT

SPEC TYPE

NOTES



Reflector

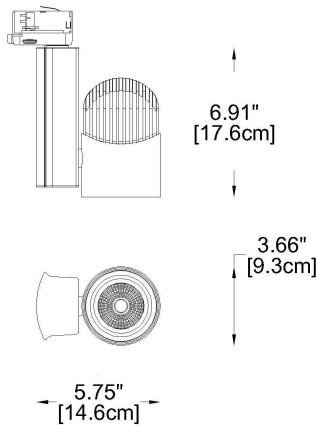

## HOW TO ORDER:

## CODE:

Example:  
CODE: BY-43-TR-65060-02-W3-K30-C80-B1-WL

BY-43-  
TR-65060-02-  
W3-K30-C80-  
B1-WL

## 1 CHOOSE TRACK HEAD:

### GENERAL INFORMATION

**CODE -** -65060-02  
 Dimensions: Ø: 5.75" (14.6 cm) x H: 6.9" (17.6 cm)  
 Housing: AL. Extrude, Electrostatic Powder Coating  
 Reflector: AL. Anodized Specular Silver  
 Gear Box: AL. Die-Casting, Electrostatic Powder Coating  
 Light Source: LED (COB)  
 Power & Currents: **-W3** - 32W / 800 mA  
**-W4** - 41W / 1050 mA

CCT: **-K30** - 3000K  
**-K40** - 4000K

CRI: **-C80** - 80  
**-C90** - 90

Beam Angle & lumens: For 32W model:  
**-B1** - 18.5° = 3517 lm  
**-B2** - 26.4° = 3411 lm  
**-B3** - 34.6° = 3421 lm

For 42W model:  
**-B1** - 18.3° = 4168 lm  
**-B2** - 26.4° = 4185 lm  
**-B3** - 34.5° = 4132 lm

Finish options: **-WL** - White  
**-BL** - Black  
**-GR** - Gray

Operating temperature range - -20 to +40°C  
 Maintenance of lumen - L80 - 50 000 hours at 25 °C

### PHOTOMETRICS:



[WWW.BULLARDCOLLECTION.COM](http://WWW.BULLARDCOLLECTION.COM)

- TECHNICAL
- OUTDOOR
- DECORATIVE



CONTACT US:

sales@gordonbullard.com  
[www.byiba.com](http://www.byiba.com)  
 1 877-964-4646

WE WELCOME ALL CUSTOM ORDERS

PROJECT

SPEC TYPE

NOTES



Lens

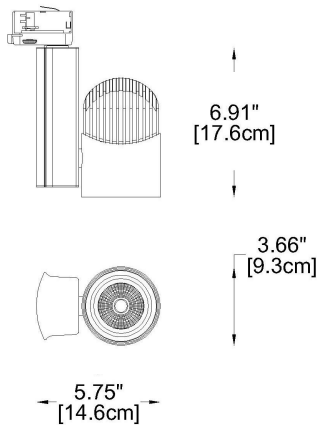

## HOW TO ORDER:

## CODE:

Example:  
CODE: BY-43-TR-65060-02-W3-K30-C80-B1-WL

BY-43-  
TR-65060-02-  
W3-K30-C80-  
B1-WL

## 1 CHOOSE TRACK HEAD:

### GENERAL INFORMATION

**CODE -** -65061-02

Dimensions: Ø: 5.75" (14.6 cm) x H: 6.9" (17.6 cm)

Housing: AL. Extrude, Electrostatic Powder Coating

Reflector: Lens

Gear Box: AL. Die-Casting, Electrostatic Powder Coating

Light Source: LED (COB)

Power & Currents: **-W3** - 32W / 800 mA  
**-W4** - 41W / 1050 mA

CCT: **-K30** - 3000K  
**-K40** - 4000K

CRI: **-C80** - 80  
**-C90** - 90

Beam Angle & lumens: For 32W model:  
**-B1** - 20.7° = 3517 lm  
**-B2** - 29.8° = 3411 lm  
**-B3** - 46.0° = 3421 lm

For 42W model:  
**-B1** - 21.0° = 4168 lm  
**-B2** - 29.8° = 4185 lm  
**-B3** - 45.9° = 4132 lm

Finish options: **-WL** - White  
**-BL** - Black  
**-GR** - Gray

Operating temperature range - -20 to +40°C  
Maintenance of lumen - L80 - 50 000 hours at 25 °C

PROJECT

SPEC TYPE

NOTES



Reflector



Lens



### HOW TO ORDER:

### CODE:

Example:  
CODE: BY-43-TR-65060-02-W3-K30-C80-B1-WL

BY-43-  
TR-65060-02-  
W3-K30-C80-  
B1-WL

### PHOTOMETRICS:

#### FOR REFLECTOR TYPE:

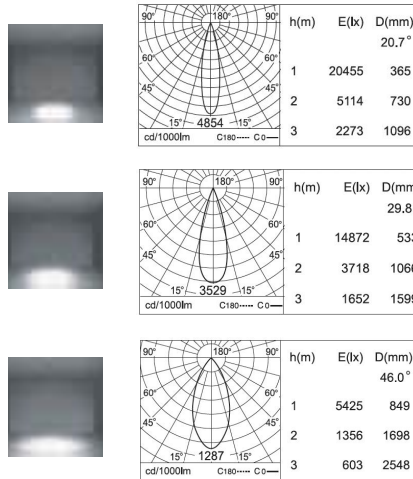

#### FOR LENS TYPE:

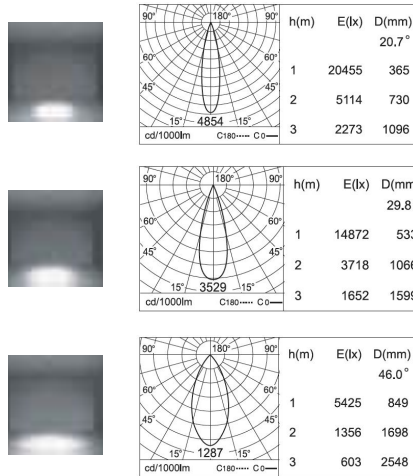

[WWW.BULLARDCOLLECTION.COM](http://WWW.BULLARDCOLLECTION.COM)

- TECHNICAL
- OUTDOOR
- DECORATIVE



CONTACT US:

sales@gordonbullard.com  
[www.byiba.com](http://www.byiba.com)  
1 877-964-4646

WE WELCOME ALL CUSTOM ORDERS

## ACCESSORIES FOR 1 CIRCUIT TRACK:

**-105**  
**Feed-in Cap**  
 -BL - Black  
 -WH - White

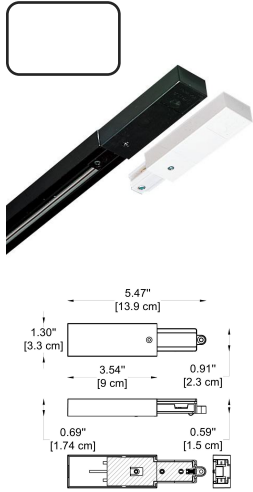

**-106**  
**End Cap**  
 -BL - Black  
 -WH - White

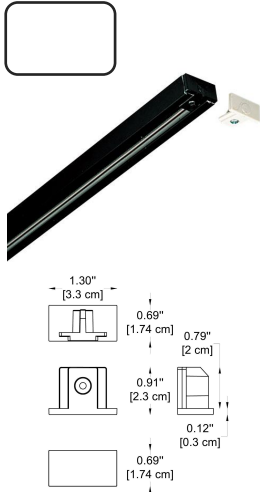

**-107**  
**Straight Connector**  
 -BL - Black  
 -WH - White

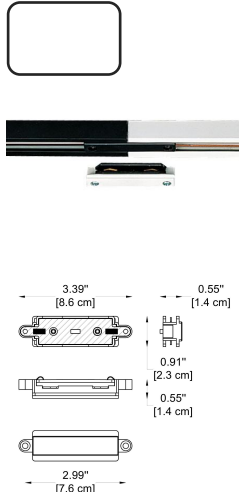

**-108**  
**L Connector**  
 -BL - Black  
 -WH - White

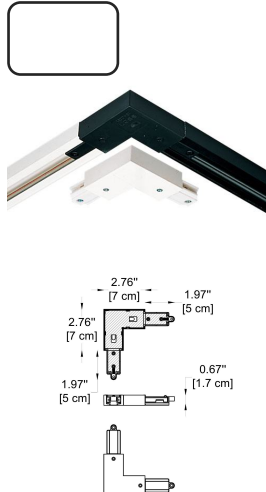

**-110**  
**T Connector**  
 -BL - Black  
 -WH - White

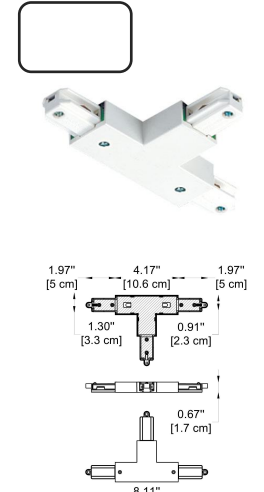

**-111**  
**X Connector**  
 -BL - Black  
 -WH - White

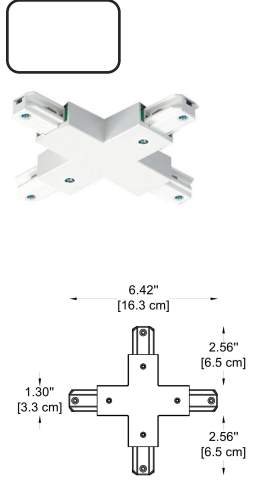

**-153**  
**Adapter**  
 -BL - Black  
 -WH - White



## HOW TO ORDER:

Example:  
 CODE: 105-WH

[WWW.BULLARDCOLLECTION.COM](http://WWW.BULLARDCOLLECTION.COM)

- TECHNICAL
- OUTDOOR
- DECORATIVE



CONTACT US:

sales@gordonbullard.com  
[www.byiba.com](http://www.byiba.com)  
 1 877-964-4646

WE WELCOME ALL CUSTOM ORDERS

## ACCESSORIES FOR 3CIRCUIT TRACK:

**-305**  
**Feed-in Cap**  
 -BL - Black  
 -WH - White

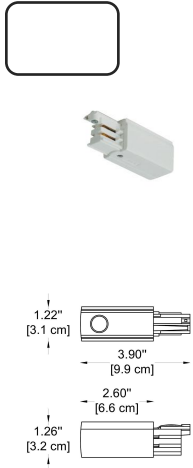

**-306**  
**End Cap**  
 -BL - Black  
 -WH - White

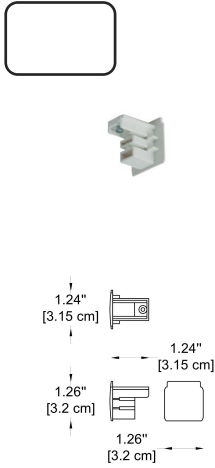

**-307**  
**Straight Connector**  
 -BL - Black  
 -WH - White

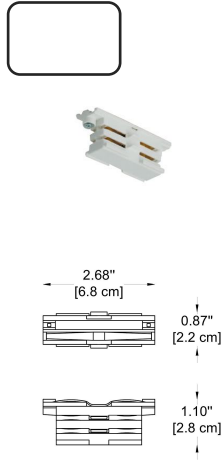

**-308**  
**L Connector**  
 -BL - Black  
 -WH - White

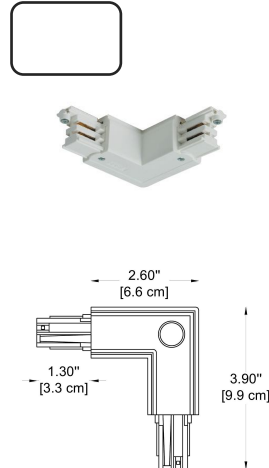

**-310**  
**T Connector**  
 -BL - Black  
 -WH - White

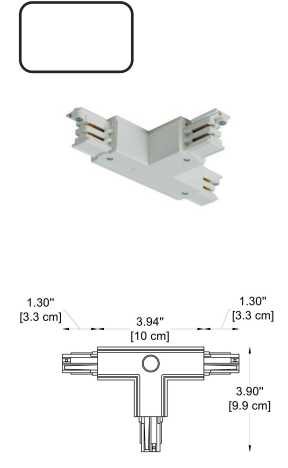

**-311**  
**X Connector**  
 -BL - Black  
 -WH - White

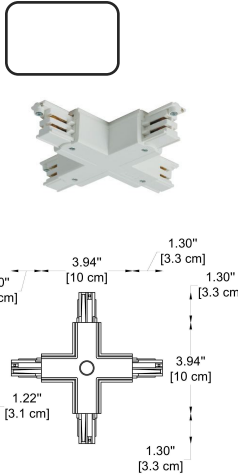

**-351**  
**Adapter**  
 -BL - Black  
 -WH - White

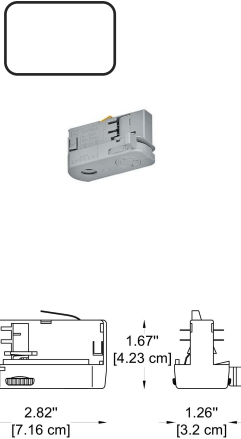

### HOW TO ORDER:

Example:  
 CODE: -305-BL

[WWW.BULLARDCOLLECTION.COM](http://WWW.BULLARDCOLLECTION.COM)

- TECHNICAL
- OUTDOOR
- DECORATIVE



CONTACT US:

sales@gordonbullard.com  
[www.byiba.com](http://www.byiba.com)  
 1 877-964-4646

WE WELCOME ALL CUSTOM ORDERS