

**BYIBA**  
L I G H T



**BELL COLLECTION**  
(track)

BY-50-TR

PROJECT

SPEC TYPE

NOTES



**GENERAL INFORMATION:**

The Bell Track Collection offers a modern DC Track System with three profile options: Surface-Mounted S, Surface-Mounted L, and Recessed. Available in black and white finishes, the system comes in lengths of 39.4", 78.7", and 118". It features spotlights and pendant lights from the Bell series, with up to 10 customizable pieces. LED lighting options include CCT of 3000K, 4000K, or 5000K, with CRI of 80 or 90. Crafted from durable aluminum with an electrostatic powder coating, this collection is perfect for versatile and stylish indoor lighting.

**MATERIAL:**

AL, Electrostatic Powder Coating

**FINISHING:**

White, Black

**LIGHTING:**

LED

**VOLTAGE:**

Low Voltage Track (48V)

**IP RATING:**

20

**OPERATING TEMPERATURE RANGE:**

-20 to +40 C

LED



IP20



2.0 kg

[WWW.BULLARDCOLLECTION.COM](http://WWW.BULLARDCOLLECTION.COM)

TECHNICAL

OUTDOOR

DECORATIVE



WE WELCOME ALL CUSTOM ORDERS

CONTACT US:

[sales@gordonbullard.com](mailto:sales@gordonbullard.com)

[www.byiba.com](http://www.byiba.com)

1 877-964-4646

PROJECT

SPEC TYPE

NOTES



HOW TO ORDER:

Example:  
CODE: BY-50-TR-1-01-65020-03-K30-C80-B1-WL

CODE:

BY-50-  
TR-1-01-6502  
0-03-K30-  
C80-B1-WL

1 CHOOSE TRACK MODEL:

Surface-Mounted S profile



-1-01 L: 39.4" (100 cm)

-1-02 L: 78.7" (200 cm)

-1-03 L: 118" (300 cm)

Surface-Mounted L profile



-2-01 L: 39.4" (100 cm)

-2-02 L: 78.7" (200 cm)

-2-03 L: 118" (300 cm)

Recessed profile



-3-01 L: 39.4" (100 cm)

-3-02 L: 78.7" (200 cm)

-3-03 L: 118" (300 cm)



[WWW.BULLARDCOLLECTION.COM](http://WWW.BULLARDCOLLECTION.COM)

TECHNICAL

OUTDOOR

DECORATIVE



WE WELCOME ALL CUSTOM ORDERS

CONTACT US:

sales@gordonbullard.com  
[www.byiba.com](http://www.byiba.com)  
1 877-964-4646

PROJECT

SPEC TYPE

NOTES

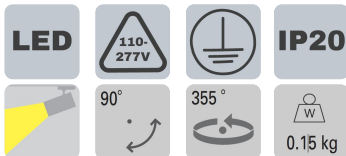
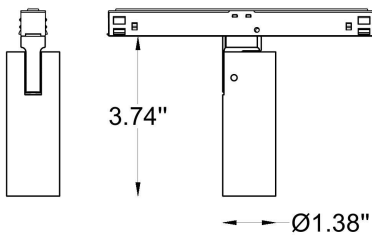

White  
Black

## HOW TO ORDER:

CODE:

Example:  
CODE: BY-50-TR-1-01-65020-03-K30-C80-B1-WL

BY-50-  
TR-1-01-6502  
0-03-K30-  
C80-B1-WL

## 1 CHOOSE TRACK MODEL:

### GENERAL INFORMATION

CODE - **-65020-03**

Dimensions: Ø: 1.4" (3.5 cm) x H: 3.74" (9.5 cm)

Housing: AL. Extrude, Electrostatic Powder Coating

Reflector: Lens

Light Source: LED

Power: 9W

CCT: **K30** - 3000K

**K40** - 4000K

**K50** - 5000K

CRI: **C80** - 80

**C90** - 90

Beam Angle **B1** - 12.5° = 419 lm

and lumens: **B2** - 17.5° = 396 lm

**B3** - 25.5° = 394 lm

Finish options: **-WL** - White

**-BL** - Black

Operating temperature range - -20 to +40°C

Maintenance of lumen - L80 - 50 000 hours at 25 °C

### PHOTOMETRICS:

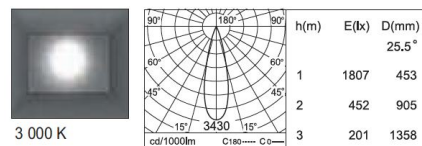
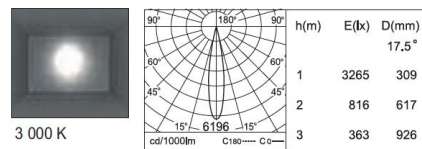
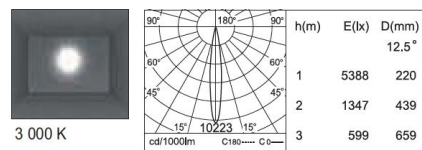

[WWW.BULLARDCOLLECTION.COM](http://WWW.BULLARDCOLLECTION.COM)

TECHNICAL

OUTDOOR

DECORATIVE



WE WELCOME ALL CUSTOM ORDERS

CONTACT US:

[sales@gordonbullard.com](mailto:sales@gordonbullard.com)

[www.byiba.com](http://www.byiba.com)

1 877-964-4646

PROJECT

SPEC TYPE

NOTES

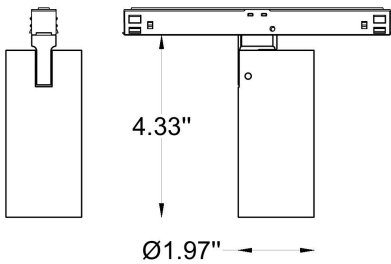

White  
 Black

## HOW TO ORDER:

CODE:

Example:  
CODE: BY-50-TR-1-01-65020-03-K30-C80-B1-WL

BY-50-TR-1-01-65020-03-K30-C80-B1-WL

## 1 CHOOSE TRACK MODEL:

### GENERAL INFORMATION

**CODE -** -65020-08  
 Dimensions: Ø: 2" (5 cm) x H: 4.33" (11 cm)  
 Housing: AL. Extrude, Electrostatic Powder Coating  
 Reflector: Lens  
 Light Source: LED (COB)  
 Power: 15W  
 CCT: **K30** - 3000K  
       **K40** - 4000K  
  
 CRI: **C80** - 80  
       **C90** - 90  
  
 Beam Angle and lumens: **B1** - 13.8° = 1 184 lm  
                               **B2** - 23.3° = 1 252 lm  
                               **B3** - 38.5° = 1 032 lm

Finish options: **-WL** - White  
                       **-BL** - Black

Operating temperature range - -20 to +40°C  
 Maintenance of lumen - L80 - 50 000 hours at 25 °C

### PHOTOMETRICS:

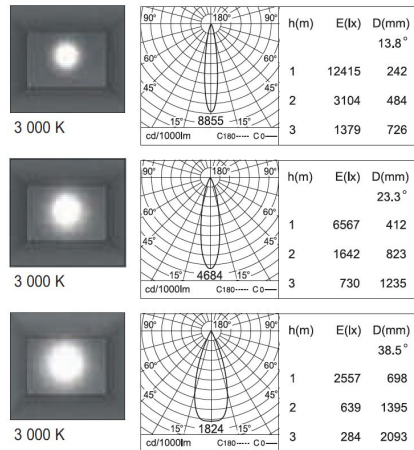

PROJECT

SPEC TYPE

NOTES

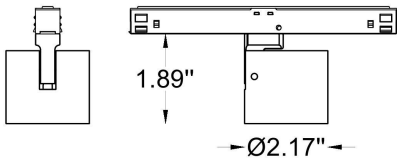

## HOW TO ORDER:

CODE:

Example:  
CODE: BY-50-TR-1-01-65020-03-K30-C80-B1-WL

BY-50-  
TR-1-01-6502  
0-03-K30-  
C80-B1-WL

## 1 CHOOSE TRACK MODEL:

### GENERAL INFORMATION

CODE - **65020-11**

Dimensions: Ø: 2.16" (5.5 cm) x H: 1.8" (4.8 cm)

Housing: AL. Extrude, Electrostatic Powder Coating

Reflector: LENS & ABS (Chrome \_Non Glare Refelctor)

Light Source: LED

Power: 9W

CCT: **-K30 - 3000K**

**-K40 - 4000K**

**-K50 - 5000K**

CRI: **-C80 - 80**

**-C90 - 90**

Beam Angle **-B1 - 12.5° = 419 lm**

and lumens: **-B2 - 17.5° = 396 lm**

**-B3 - 25.5° = 394 lm**

Finish options: **-WL - White**

**-BL - Black**

Operating temperature range - **-20 to +40°C**

Maintenance of lumen - L80 - **50 000 hours at 25 °C**

### PHOTOMETRICS:

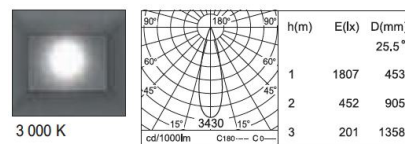
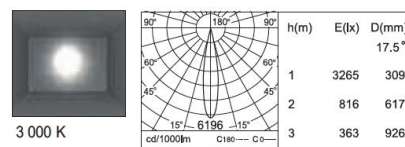
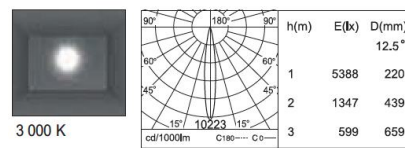

[WWW.BULLARDCOLLECTION.COM](http://WWW.BULLARDCOLLECTION.COM)

TECHNICAL

OUTDOOR

DECORATIVE



WE WELCOME ALL CUSTOM ORDERS

CONTACT US:

[sales@gordonbullard.com](mailto:sales@gordonbullard.com)

[www.byiba.com](http://www.byiba.com)

1 877-964-4646

PROJECT

SPEC TYPE

NOTES

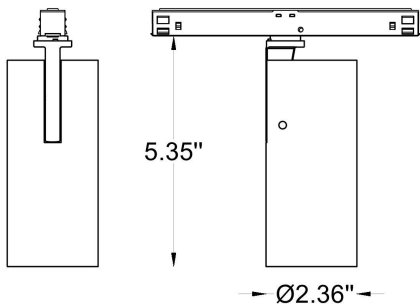

LED

110-277V

IP20

90°

355°

0.3 kg

White

Black

## HOW TO ORDER:

## CODE:

Example:  
CODE: BY-50-TR-1-01-65020-03-K30-C80-B1-WL

BY-50-TR-1-01-65020-03-K30-C80-B1-WL

## 1 CHOOSE TRACK MODEL:

### GENERAL INFORMATION

**CODE -** -65030-03

Dimensions: Ø: 2.36" (6 cm) x H: 5.35" (13.6 cm)

Housing: AL. Extrude, Electrostatic Powder Coating

Reflector: Lens

Light Source: LED (COB)

Power: 24W

CCT: **K30** - 3000K  
**K40** - 4000K

CRI: **C80** - 80  
**C90** - 90

Beam Angle and lumens: **B1** - 23.5° = 2 610 lm  
**B2** - 31° = 2 623 lm  
**B3** - 47.2° = 2 676 lm

Finish options: **-WL** - White  
**-BL** - Black

Operating temperature range - -20 to +40°C  
Maintenance of lumen - L80 - 50 000 hours at 25 °C

### PHOTOMETRICS:

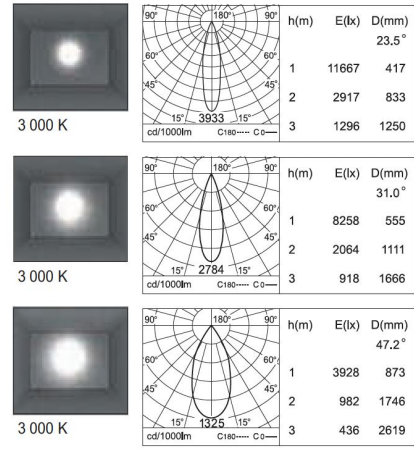

PROJECT

SPEC TYPE

NOTES

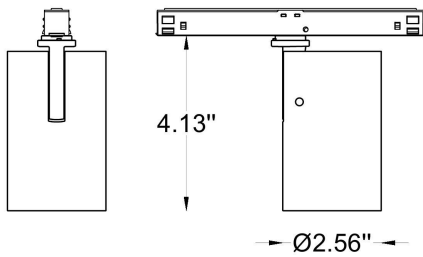

LED
110-277V
IP20
White
Black

90°
355°
0.7 kg

## HOW TO ORDER:

## CODE:

Example:  
CODE: BY-50-TR-1-01-65020-03-K30-C80-B1-WL

BY-50-  
TR-1-01-6502  
0-03-K30-  
C80-B1-WL

## 1 CHOOSE TRACK MODEL:

### GENERAL INFORMATION

**CODE -** -65030-11  
 Dimensions: Ø: 2.55" (6.5 cm) x H: 4.13" (10.5 cm)  
 Housing: AL Die-Casting, Electrostatic Powder Coating  
 Reflector: PC (Vacuum Coating)  
 Light Source: LED (COB)  
 Power: 14W  
 CCT: -K30 - 3000K  
       -K40 - 4000K

CRI: -C80 - 80  
       -C90 - 90

Beam Angle and lumens: -B1 - 15.5° = 1 450 lm  
                               -B2 - 28.2° = 1 344 lm  
                               -B3 - 39.5° = 1 357 lm

Finish options: -WL - White  
                       -BL - Black

Operating temperature range - -20 to +40°C  
 Maintenance of lumen - L80 - 50 000 hours at 25 °C

### PHOTOMETRICS:

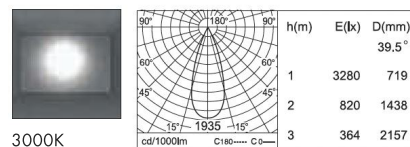
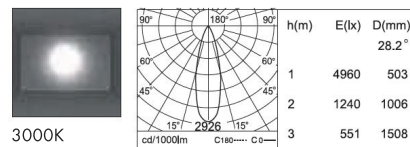
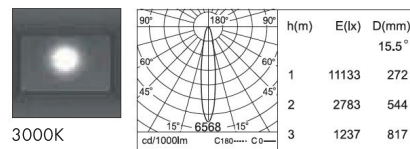

WWW.BULLARDCOLLECTION.COM

- TECHNICAL
- OUTDOOR
- DECORATIVE



CONTACT US:

[sales@gordonbullard.com](mailto:sales@gordonbullard.com)  
[www.byiba.com](http://www.byiba.com)  
 1 877-964-4646

WE WELCOME ALL CUSTOM ORDERS



PROJECT

SPEC TYPE

NOTES

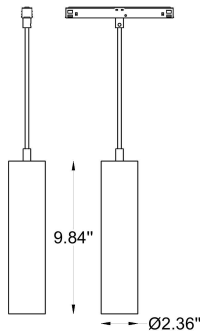

LED

110-277V

IP20

0.6 kg

White

Black

## HOW TO ORDER:

CODE:

Example:  
CODE: BY-50-TR-1-01-65020-03-K30-C80-B1-WL

BY-50-  
TR-1-01-6502  
0-03-K30-  
C80-B1-WL

## 1 CHOOSE TRACK MODEL:

### GENERAL INFORMATION

CODE - **-51220-03**  
 Dimensions: Ø: 2.36" (6 cm) x H: 7.87" (25 cm)  
 Housing: AL. Extrude, Electrostatic Powder Coating  
 Reflector: Lens  
 Light Source: LED (COB)  
 Power: 14W  
 CCT: **-K30 - 3000K**  
**-K40 - 4000K**

CRI: **-C80 - 80**  
**-C90 - 90**

Beam Angle and lumens: **-B1 - 15.5° = 1 318 lm**  
**-B2 - 27.2° = 1 281 lm**  
**-B3 - 37.8° = 1 309 lm**

Finish options: **-WL - White**  
**-BL - Black**

Operating temperature range - -20 to +40°C  
 Maintenance of lumen - L80 - 50 000 hours at 25 °C

### PHOTOMETRICS:

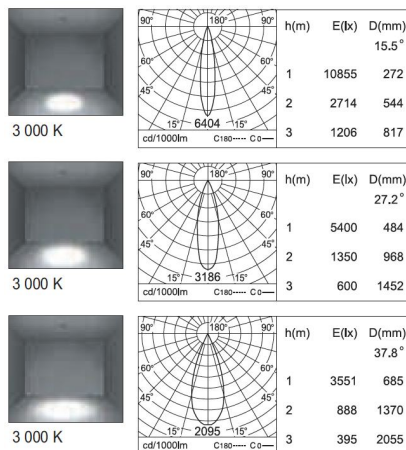

PROJECT

SPEC TYPE

NOTES

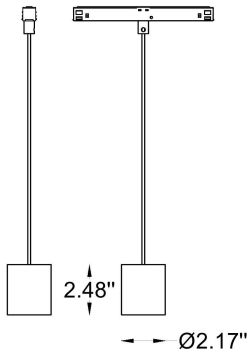
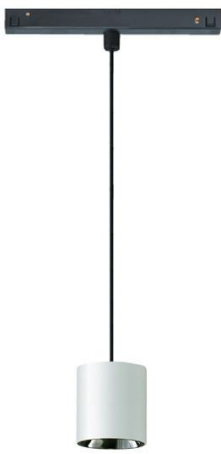

## HOW TO ORDER:

Example:  
CODE: BY-50-TR-1-01-65020-03-K30-C80-B1-WL

## CODE:

BY-50-  
TR-1-01-6502  
0-03-K30-  
C80-B1-WL

## 1 CHOOSE TRACK MODEL:

### GENERAL INFORMATION

**CODE -** -51240-11  
 Dimensions: Ø: 2.16" (5.5 cm) x H: 2.1" (5.3 cm)  
 Housing: AL. Extrude, Electrostatic Powder Coating  
 Reflector: LENS & ABS (Chrome \_Non Glare Refelctor)  
 Light Source: LED  
 Power: 9W  
 CCT: **-K30** - 3000K  
**-K40** - 4000K  
**-K50** - 5000K

CRI:  
**-C80** - 80  
**-C90** - 90

Beam Angle and lumens:  
**-B1** - 12.5° = 419 lm  
**-B2** - 17.5° = 396 lm  
**-B3** - 25.5° = 394 lm

Finish options: **-WL** - White  
**-BL** - Black

Operating temperature range - -20 to +40°C  
 Maintenance of lumen - L80 - 50 000 hours at 25 °C

### PHOTOMETRICS:

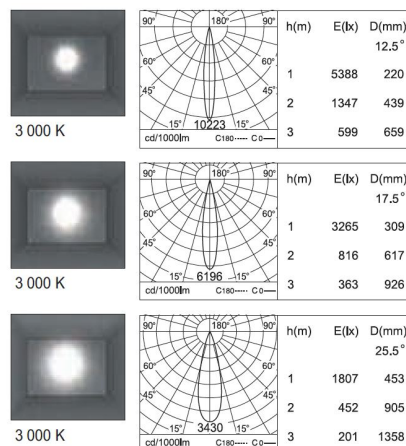

[WWW.BULLARDCOLLECTION.COM](http://WWW.BULLARDCOLLECTION.COM)

TECHNICAL

OUTDOOR

DECORATIVE



WE WELCOME ALL CUSTOM ORDERS

CONTACT US:

sales@gordonbullard.com  
[www.byiba.com](http://www.byiba.com)  
 1 877-964-4646

PROJECT

SPEC TYPE

NOTES

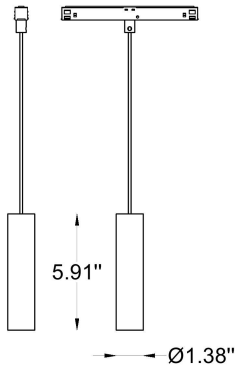

LED

110-277V

IP20

0.15 kg

White

Black

## HOW TO ORDER:

Example:  
CODE: BY-50-TR-1-01-65020-03-K30-C80-B1-WL

## CODE:

BY-50-  
TR-1-01-6502  
0-03-K30-  
C80-B1-WL

## 1 CHOOSE TRACK MODEL:

### GENERAL INFORMATION

**CODE -** -51240-03

Dimensions: Ø: 1.37" (3.5 cm) x H: 5.9" (15 cm)

Housing: AL. Extrude, Electrostatic Powder Coating

Reflector: Lens

Light Source: LED

Power: 9W

CCT: -K30 - 3000K  
-K40 - 4000K  
-K50 - 5000K

CRI: -C80 - 80  
-C90 - 90

Beam Angle and lumens: -B1 - 12.5° = 419 lm  
-B2 - 17.5° = 396 lm  
-B3 - 25.5° = 394 lm

Finish options: -WL - White  
-BL - Black

Operating temperature range - -20 to +40°C  
Maintenance of lumen - L80 - 50 000 hours at 25 °C

### PHOTOMETRICS:

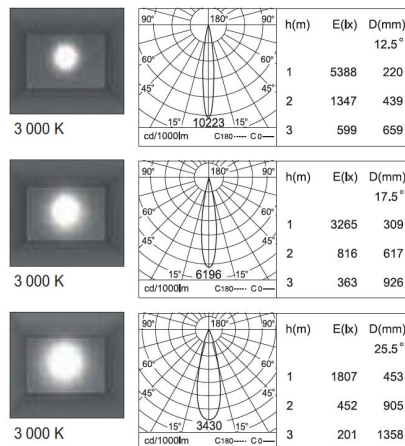

PROJECT

SPEC TYPE

NOTES

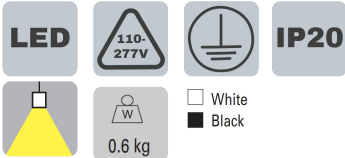
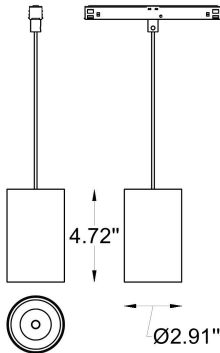

## HOW TO ORDER:

Example:  
CODE: BY-50-TR-1-01-65020-03-K30-C80-B1-WL

## CODE:

BY-50-  
TR-1-01-6502  
0-03-K30-  
C80-B1-WL

## 1 CHOOSE TRACK MODEL:

### GENERAL INFORMATION

**CODE -** -51400-11  
 Dimensions: Ø: 2.9" (7.4 cm) x H: 4.7" (12 cm)  
 Housing: AL. Extrude, Electrostatic Powder Coating  
 Reflector: ABS (Chrome)  
 Wire: PVC  
 Light Source: LED (COB)  
 Power: 20W  
 CCT: -K30 - 3000K  
 -K40 - 4000K

CRI: -C80 - 80  
 -C90 - 90

Beam Angle and lumens: -B1 - 21.8° = 1 535 lm  
 -B2 - 28.5° = 1 526 lm  
 -B3 - 40.0° = 1 708 lm

Finish options: -WL - White  
 -BL - Black

Operating temperature range - -20 to +40°C  
 Maintenance of lumen - L80 - 50 000 hours at 25 °C

### PHOTOMETRICS:

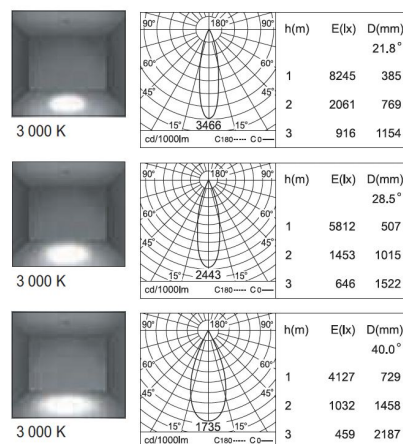

[WWW.BULLARDCOLLECTION.COM](http://WWW.BULLARDCOLLECTION.COM)



CONTACT US:

TECHNICAL

OUTDOOR

DECORATIVE

sales@gordonbullard.com  
[www.byiba.com](http://www.byiba.com)  
 1 877-964-4646

WE WELCOME ALL CUSTOM ORDERS

PROJECT

SPEC TYPE

NOTES

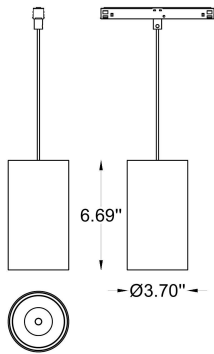

## HOW TO ORDER:

Example:  
CODE: BY-50-TR-1-01-65020-03-K30-C80-B1-WL

## CODE:

BY-50-  
TR-1-01-6502  
0-03-K30-  
C80-B1-WL

## 1 CHOOSE TRACK MODEL:

### GENERAL INFORMATION

**CODE -** -51410-11  
 Dimensions: Ø: 3.7" (9.4 cm) x H: 4.7" (12 cm)  
 Housing: AL. Die-Casting, Electrostatic Powder Coating  
 Reflector: ABS (Chrome)  
 Wire: PVC  
 Light Source: LED (COB)  
 Power: 30W  
 CCT: -K30 - 3000K  
           -K40 - 4000K  
  
 CRI: -C80 - 80  
       -C90 - 90  
  
 Beam Angle 28.9°  
 Lumens 2 303 lm  
  
 Finish options: -WL - White  
                   -BL - Black

Operating temperature range - -20 to +40°C  
 Maintenance of lumen - L80 - 50 000 hours at 25 °C

### PHOTOMETRICS:

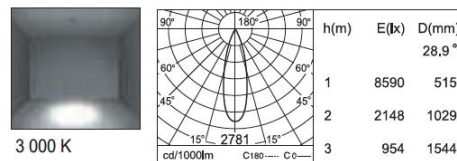

[WWW.BULLARDCOLLECTION.COM](http://WWW.BULLARDCOLLECTION.COM)

TECHNICAL

OUTDOOR

DECORATIVE



CONTACT US:

sales@gordonbullard.com  
[www.byiba.com](http://www.byiba.com)  
 1 877-964-4646

WE WELCOME ALL CUSTOM ORDERS